

253-14 ábra

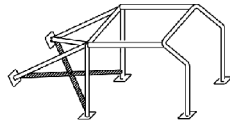

253-15 ábra

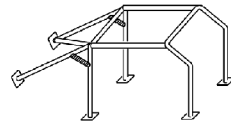

253-16 ábra

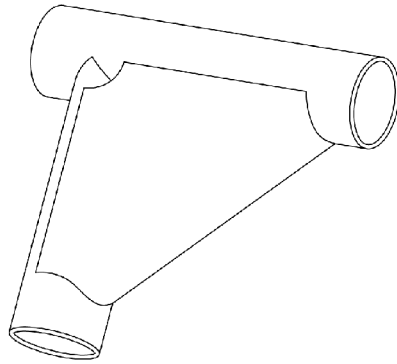

253-16A ábra

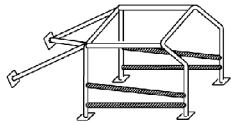

253-17 ábra

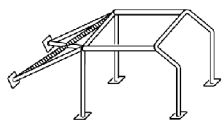

253-17A ábra

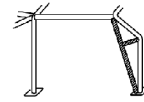

253-17B ábra

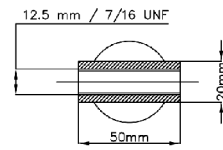
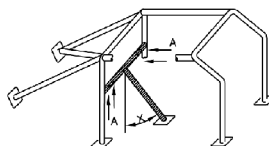
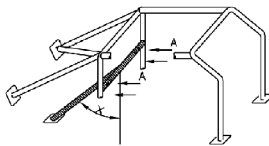

Ⓐ szerelési furatok biztonsági ív számára

ⓧ minimum 30 fok

az A nagyítása

253-17C ábra